

## Features

- Small SMD package: 2.0 x 1.2 mm (2012)<sup>[1]</sup>
- Pin-compatible to 2012 XTAL SMD package
- Fixed 32.768 kHz output frequency
- <20 ppm frequency tolerance
- Ultra-low power: <1  $\mu$ A
- Supports coin-cell or super-cap battery backup voltages
- Vdd supply range: 1.5V to 3.63V over -40°C to +85°C
- Oscillator output eliminates external load caps
- Internal filtering eliminates external Vdd bypass cap
- NanoDrive™ programmable output swing for lowest power
- Pb-free, RoHS and REACH compliant

## Applications

- Mobile Phones
- Tablets
- Health and Wellness Monitors
- Fitness Watches
- Sport Video Cams
- Wireless Keypads
- Ultra-Small Notebook PC
- Pulse-per-Second (pps) Timekeeping
- RTC Reference Clock
- Battery Management Timekeeping

Note: 1. For the smallest 32 kHz XO in CSP (1.2mm<sup>2</sup>), consider the SiT1532



## Electrical Characteristics

Parameter	Symbol	Min.	Typ.	Max.	Unit	Condition
<b>Frequency and Stability</b>						
Fixed Output Frequency	F <sub>out</sub>		32.768		kHz	
<b>Frequency Stability</b>						
Frequency Tolerance <sup>[2]</sup>	F <sub>tol</sub>			20	ppm	T <sub>A</sub> = 25°C, post reflow, Vdd: 1.5V – 3.63V.
Frequency Stability <sup>[3]</sup>	F <sub>stab</sub>			75	ppm	T <sub>A</sub> = -10°C to +70°C, Vdd: 1.5V – 3.63V.
				100		T <sub>A</sub> = -40°C to +85°C, Vdd: 1.5V – 3.63V.
				250		T <sub>A</sub> = -10°C to +70°C, Vdd: 1.2V – 1.5V.
25°C Aging		-1		1	ppm	1st Year
<b>Supply Voltage and Current Consumption</b>						
Operating Supply Voltage	Vdd	1.2		3.63	V	T <sub>A</sub> = -10°C to +70°C
		1.5		3.63	V	T <sub>A</sub> = -40°C to +85°C
Core Operating Current <sup>[4]</sup>	I <sub>dd</sub>		0.90		$\mu$ A	T <sub>A</sub> = 25°C, Vdd: 1.8V. No load
				1.3		T <sub>A</sub> = -10°C to +70°C, Vdd max: 3.63V. No load
				1.4		T <sub>A</sub> = -40°C to +85°C, Vdd max: 3.63V. No load
Output Stage Operating Current <sup>[4]</sup>	I <sub>dd_out</sub>		0.065	0.125	$\mu$ A/Vpp	T <sub>A</sub> = -40°C to +85°C, Vdd: 1.5V – 3.63V. No load
Power-Supply Ramp	t <sub>Vdd_Ramp</sub>			100	ms	T <sub>A</sub> = -40°C to +85°C, 0 to 90% Vdd
Start-up Time at Power-up <sup>[5]</sup>	t <sub>start</sub>		180	300	ms	T <sub>A</sub> = -40°C ≤ T <sub>A</sub> ≤ +50°C, valid output
				450		T <sub>A</sub> = +50°C < T <sub>A</sub> ≤ +85°C, valid output
<b>Operating Temperature Range</b>						
Commercial Temperature	T <sub>use</sub>	-10		70	°C	
Industrial Temperature		-40		85	°C	

### Notes:

2. Measured peak-to-peak. Tested with Agilent 53132A frequency counter. Due to the low operating frequency, the gate time must be ≥100 ms to ensure an accurate frequency measurement.
3. Stability is specified for two operating voltage ranges. Stability progressively degrades with supply voltage below 1.5V. Measured peak-to-peak. Inclusive of Initial Tolerance at 25°C, and variations over operating temperature, rated power supply voltage and load.
4. Core operating current does not include output driver operating current or load current. To derive total operating current (no load), add core operating current + (0.065  $\mu$ A/V) \* (peak-to-peak output Voltage swing).
5. Measured from the time Vdd reaches 1.5V.

## Electrical Characteristics (continued)

Parameter	Symbol	Min.	Typ.	Max.	Unit	Condition
<b>LVC MOS Output Option, <math>T_A = -40^\circ\text{C}</math> to <math>+85^\circ\text{C}</math>, typical values are at <math>T_A = 25^\circ\text{C}</math></b>						
Output Rise/Fall Time	tr, tf		100	200	ns	10-90% (Vdd), 15 pF load, Vdd = 1.5V to 3.63V
				50		10-90% (Vdd), 5 pF load, Vdd $\geq$ 1.62V
Output Clock Duty Cycle	DC	48		52	%	
Output Voltage High	VOH	90%			V	Vdd: 1.5V – 3.63V. I <sub>OH</sub> = -10 $\mu$ A, 15 pF
Output Voltage Low	VOL			10%	V	Vdd: 1.5V – 3.63V. I <sub>OL</sub> = 10 $\mu$ A, 15 pF
<b>NanoDrive™ Programmable, Reduced Swing Output</b>						
Output Rise/Fall Time	tr, tf			200	ns	30-70% (V <sub>OL</sub> /V <sub>OH</sub> ), 10 pF Load
Output Clock Duty Cycle	DC	48		52	%	
AC-coupled Programmable Output Swing	V <sub>sw</sub>		0.20 to 0.80		V	SiT1533 does not internally AC-couple. This output description is intended for a receiver that is AC-coupled. See Table 2 for acceptable NanoDrive swing options. Vdd: 1.5V – 3.63V, 10 pF Load, I <sub>OH</sub> / I <sub>OL</sub> = $\pm$ 0.2 $\mu$ A.
DC-Biased Programmable Output Voltage High Range	VOH		0.60 to 1.225		V	Vdd: 1.5V – 3.63V. I <sub>OH</sub> = -0.2 $\mu$ A, 10 pF Load. See Table 1 for acceptable V <sub>OH</sub> /V <sub>OL</sub> setting levels.
DC-Biased Programmable Output Voltage Low Range	VOL		0.35 to 0.80		V	Vdd: 1.5V – 3.63V. I <sub>OL</sub> = 0.2 $\mu$ A, 10 pF Load. See Table 1 for acceptable V <sub>OH</sub> /V <sub>OL</sub> setting levels.
Programmable Output Voltage Swing Tolerance		-0.055		0.055	V	$T_A = -40^\circ\text{C}$ to $+85^\circ\text{C}$ , Vdd = 1.5V to 3.63V.
Period Jitter	T <sub>jitt</sub>		35		ns <sub>RMS</sub>	Cycles = 10,000, $T_A = 25^\circ\text{C}$ , Vdd = 1.5V – 3.63V

## Pin Configuration

SMD Pin	Symbol	I/O	Functionality
1	NC	No Connect	No Connect. Will not respond to any input signal. When interfacing to an MCU's XTAL input pins, this pin is typically connected to the receiving IC's X Out pin. In this case, the SiT1533 will not be affected by the signal on this pin. If not interfacing to an XTAL oscillator, leave pin 1 floating (no connect).
2	GND	Power Supply Ground	Connect to ground. All GND pins must be connected to power supply ground.
3	CLK Out	OUT	Oscillator clock output. When interfacing to an MCU's XTAL, the CLK Out is typically connected to the receiving IC's X IN pin. The SiT1533 oscillator output includes an internal driver. As a result, the output swing and operation is not dependent on capacitive loading. This makes the output much more flexible, layout independent, and robust under changing environmental and manufacturing conditions.
4	Vdd	Power Supply	Connect to power supply 1.5V $\leq$ Vdd $\leq$ 3.63V for operation over $-40^\circ\text{C}$ to $+85^\circ\text{C}$ temperature range. Under normal operating conditions, Vdd does not require external bypass/decoupling capacitor(s). Internal power supply filtering will reject more than $\pm$ 150 mVpp with frequency components through 10 MHz. Contact factory for applications that require a wider operating supply voltage range.

## SMD Package (Top View)

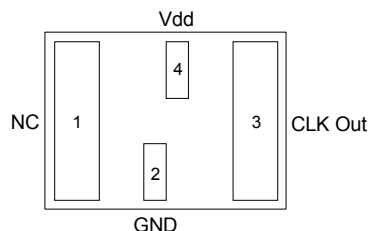

### System Block Diagram

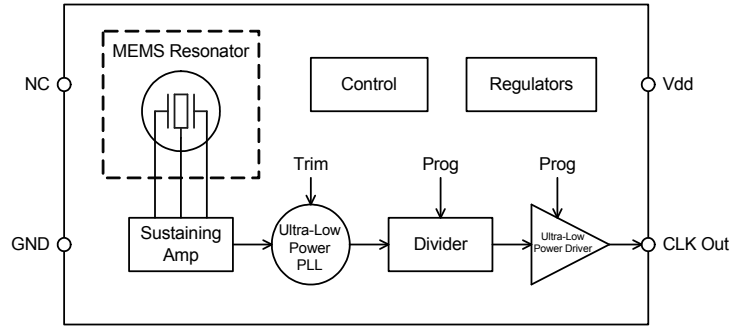

Figure 1.

### Absolute Maximum

Attempted operation outside the absolute maximum ratings may cause permanent damage to the part. Actual performance of the IC is only guaranteed within the operational specifications, not at absolute maximum ratings.

Parameter	Test Condition	Value	Unit
Continuous Power Supply Voltage Range (Vdd)		-0.5 to 3.63	V
Short Duration Maximum Power Supply Voltage (Vdd)	≤30 minutes, over -40°C to +85°C	4.0	V
Continuous Maximum Operating Temperature Range	Vdd = 1.5V - 3.63V	105	°C
Short Duration Maximum Operating Temperature Range	Vdd = 1.5V - 3.63V, ≤30 mins	125	°C
Human Body Model ESD Protection	HBM, JESD22-A114	3000	V
Charge-Device Model (CDM) ESD Protection	JESD220C101	750	V
Machine Model (MM) ESD Protection	T <sub>A</sub> = 25°C	300	V
Latch-up Tolerance	JESD78 Compliant		
Mechanical Shock Resistance	Mil 883, Method 2002	10,000	g
Mechanical Vibration Resistance	Mil 883, Method 2007	70	g
2012 SMD Junction Temperature		150	°C
Storage Temperature		-65°C to 150°C	

### Description

The SiT1533 is an ultra-small and ultra-low power 32.768 kHz oscillator optimized for mobile and other battery-powered applications. The SiT1533 is pin-compatible and footprint compatible to existing 2012 XTALs when using the SiTime solder-pad layout (SPL). And unlike standard oscillators, the SiT1533 features NanoDrive™, a factory programmable output that reduces the voltage swing to minimize power.

The 1.2V to 3.63V operating supply voltage range makes it an ideal solution for mobile applications that incorporate a low-voltage, battery-back-up source such as a coin-cell or super-cap.

SiTime's MEMS oscillators consist of MEMS resonators and a programmable analog circuit. Our MEMS resonators are built with SiTime's unique MEMS First™ process. A key manufacturing step is EpiSeal™ during which the MEMS resonator is annealed with temperatures over 1000°C. EpiSeal creates an extremely strong, clean, vacuum chamber that encapsulates the MEMS resonator and ensures the best performance and reliability. During EpiSeal, a poly silicon cap is grown on top of the resonator cavity, which eliminates the need for additional cap wafers or other exotic packaging. As a result, SiTime's MEMS resonator die can be used like any other semiconductor die. One unique result of SiTime's MEMS First and EpiSeal manufacturing processes is the capability to integrate SiTime's MEMS die with a SOC, ASIC, microprocessor or analog die within a package to eliminate external timing components and provide a highly integrated, smaller, cheaper solution to the customer.

### XTAL Footprint Compatibility (SMD Package)

The SiT1533 is a replacement to the 32 kHz XTAL in the 2.0 x 1.2 mm (2012) package. Unlike XTAL resonators, SiTime's silicon MEMS oscillators require a power supply (Vdd) and ground (GND) pin. Vdd and GND pins are conveniently placed between the two large XTAL pins. When using the SiTime Solder Pad Layout (SPL), the SiT1533 footprint is compatible with existing 32 kHz XTALs in the 2012 SMD package. Figure 2 shows the comparison between the quartz XTAL footprint and the SiTime footprint. For applications that require the smallest footprint solution, consider the SiT1532 XO available in a 1.2mm<sup>2</sup> CSP.

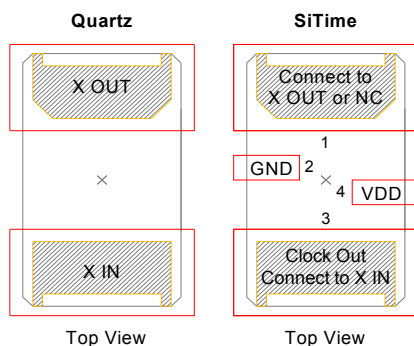

**Figure 2. SiT1533 Footprint Compatibility with Quartz XTAL Footprint [6]**

Note:

6. On the SiTime device, X IN is not internally connected and will not respond to any signal. It is acceptable to connect to chipset X OUT.

### Frequency Stability

The SiT1533 is factory calibrated (trimmed) to guarantee frequency stability to be less than 20 ppm at room temperature and less than 100 ppm over the full -40°C to +85°C temperature range. Unlike quartz crystals that have a classic tuning fork parabola temperature curve with a 25°C turnover point, the SiT1533 temperature coefficient is extremely flat across temperature. The device maintains less than 100 ppm frequency stability over the full operating temperature range when the operating voltage is between 1.5 and 3.63V as shown in Figure 3.

Functionality is guaranteed over the 1.2V - 3.63V operating supply voltage range. However, frequency stability degrades below 1.5V and steadily degrades as it approaches the 1.2V minimum supply due to the internal regulator limitations. Between 1.2V and 1.5V, the frequency stability is 250 ppm max over temperature.

When measuring the SiT1533 output frequency with a frequency counter, it is important to make sure the counter's gate time is ≥100ms. The slow frequency of a 32 kHz clock will give false readings with faster gate times.

For applications that require a wider supply voltage range >3.63V, or operating frequency below 32 kHz, see the alternative 32 kHz product options on the SiTime web site; [www.sitime.com](http://www.sitime.com).

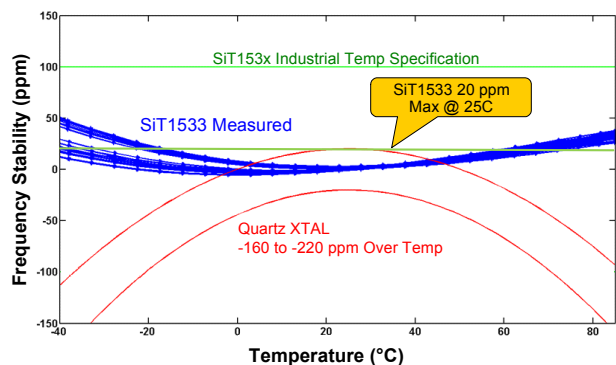

**Figure 3. SiTime vs. Quartz**

### Power Supply Noise Immunity

The SiT1533 is an ultra-small 32 kHz oscillator. In addition to eliminating external output load capacitors common with standard XTALs, this device includes special power supply filtering and thus, eliminates the need for an external Vdd bypass-decoupling capacitor. This feature further simplifies the design and keeps the footprint as small as possible. Internal power supply filtering is designed to reject AC-noise greater than ±150 mVpp magnitude and beyond 10 MHz frequency component.

### Output Voltage

The SiT1533 has two output voltage options. One option is a standard LVCMOS output swing. The second option is the NanoDrive reduced swing output. Output swing is customer specific and programmed between 200 mV and 800 mV. For

DC-coupled applications, output  $V_{OH}$  and  $V_{OL}$  are individually factory programmed to the customers' requirement.  $V_{OH}$  programming range is between 600 mV and 1.225V in 100 mV increments. Similarly,  $V_{OL}$  programming range is between 350 mV and 800 mV. For example; a PMIC or MCU is internally 1.8V logic compatible, and requires a 1.2V  $V_{IH}$  and a 0.6V  $V_{IL}$ . Simply select SiT1533 NanoDrive factory programming code to be "D14" and the correct output thresholds will match the downstream PMIC or MCU input requirements. Interface logic will vary by manufacturer and we recommend that you review the input voltage requirements for the input interface.

For DC-biased NanoDrive output configuration, the minimum  $V_{OL}$  is limited to 350mV and the maximum allowable swing ( $V_{OH} - V_{OL}$ ) is 750mV. For example, 1.1V  $V_{OH}$  and 400mV  $V_{OL}$  is acceptable, but 1.2V  $V_{OH}$  and 400 mV  $V_{OL}$  is not acceptable.

When the output is interfacing to an XTAL input that is internally AC-coupled, the SiT1533 output can be factory programmed to match the input swing requirements. For example, if a PMIC or MCU input is internally AC-coupled and requires an 800mV swing, then simply choose the SiT1533 NanoDrive programming code "AA8" in the part number. It is important to note that the SiT1533 does not include internal AC-coupling capacitors. Please see the *Part Number Ordering* section at the end of the datasheet for more information about the part number ordering scheme.

### Power-up

The SiT1533 starts-up to a valid output frequency within 300 ms (150ms typ). To ensure the device starts-up within the specified limit, make sure the power-supply ramps-up in approximately 10 - 20 ms (to within 90% of Vdd). Start-up time is measured from the time Vdd reaches 1.5V. For applications that operate between 1.2V and 1.5V, the start-up time will be longer.

### SiT1533 NanoDrive™

Figure 4 shows a typical SiT1533 output waveform (into a 10 pF load) when factory programmed for a 0.70V swing and DC bias ( $V_{OH}/V_{OL}$ ) for 1.8V logic:

#### Example:

- NanoDrive™ part number coding: D14. Example part number: SiT1533AI-H4-D14-32.768
- $V_{OH} = 1.1V$ ,  $V_{OL} = 0.4V$  ( $V_{SW} = 0.70V$ )

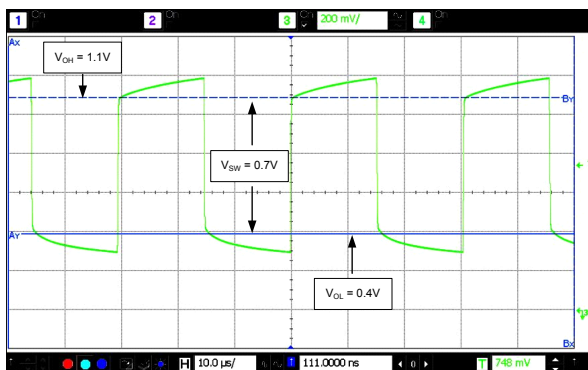

Figure 4. SiT1533AI-H4-D14-32.768 Output Waveform (10 pF load)

Table 1 shows the supported NanoDrive™  $V_{OH}$ ,  $V_{OL}$  factory programming options.

Table 1. Acceptable  $V_{OH}/V_{OL}$  NanoDrive™ Levels

$V_{OL}/V_{OH}$	1.225	1.100	1.000	0.900	0.800	0.700	0.600
0.800	D28	D18	D08				
0.700	D27	D17	D07	D97			
0.525	D26	D16	D06	D96	D86		
0.500	D25	D15	D05	D95	D85	D75	
0.400		D14	D04	D94	D84	D74	D64
0.350		D13	D03	D93	D83	D73	D63

Table 2 shows the supported AC coupled Swing levels. The "AC-coupled" terminology refers to the programming description for applications where the downstream chipset includes an internal AC-coupling capacitor, and therefore, only the output swing is important and  $V_{OH}/V_{OL}$  are not relevant.

Table 2. Acceptable AC-Coupled Swing Levels

Swing	0.800	0.700	0.600	0.500	0.400	0.300	0.250	0.200
Output Code	AA8	AA7	AA6	AA5	AA4	AA3	AA2	AA1

#### Example:

- NanoDrive part number coding: AA2. Example part number: SiT1533AI-D4-AA2-32.768
- Output voltage swing: 0.250V

The values listed in Tables 1 and -2 are nominal values at 25°C and will exhibit a tolerance of ±55 mV across Vdd and -40°C to 85°C operating temperature range.

### SiT1533 Full Swing LVCMOS Output

The SiT1533 can be factory programmed to generate full-swing LVCMOS levels. Figure 5 shows the typical LVCMOS waveform ( $V_{dd} = 1.8V$ ) at room temperature into a 15 pF load.

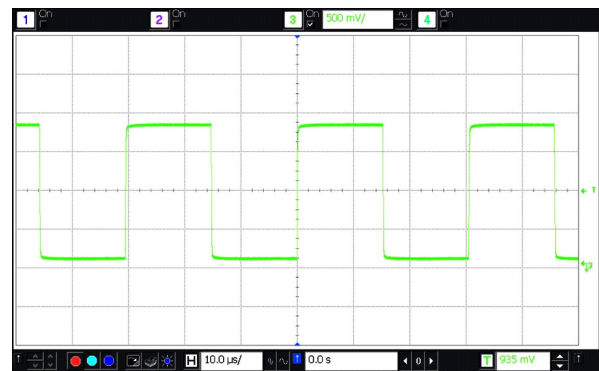

Figure 5. LVCMOS Waveform ( $V_{dd} = 1.8V$ ) into 15 pF Load

#### Example:

- LVCMOS output part number coding is always DCC
- Example part number: SiT1533AI-H4-DCC-32.768

## Calculating Load Current

### No Load Supply Current

When calculating no-load power for the SiT1533, the core and output driver components need to be added. Since the output voltage swing can be programmed for reduced swing between 250 mV and 800 mV, the output driver current is variable. Therefore, no-load operating supply current is broken into two sections; core and output driver. The equation is as follows:

$$\text{Total Supply Current (no load)} = I_{dd} \text{ Core} + (65\text{nA/V})(V_{out_{pp}})$$

#### **Example 1: Full-swing LVCMOS**

- Vdd = 1.8V
- Idd Core = 900nA (typ)
- Vout<sub>pp</sub> = 1.8V (LVCMOS)

$$\text{Supply Current} = 900\text{nA} + (65\text{nA/V})(1.8\text{V}) = 1017\text{nA}$$

#### **Example 2: NanoDrive™ Reduced Swing**

- Vdd = 1.8V
- Idd Core = 900nA (typ)
- Vout<sub>pp</sub> (Programmable) = V<sub>OH</sub> - V<sub>OL</sub> = 1.1V - 0.6V = 500 mV

$$\text{Supply Current} = 900\text{nA} + (65\text{nA/V})(0.5\text{V}) = 932\text{nA}$$

## Total Supply Current with Load

To calculate the total supply current, including the load, follow the equation listed below. Note the 30% reduction in power with NanoDrive™.

$$\text{Total Current} = I_{dd} \text{ Core} + I_{dd} \text{ Output Driver} (65\text{nA/V} \cdot V_{out_{pp}}) + \text{Load Current} (C \cdot V \cdot F)$$

#### **Example 1: Full-swing LVCMOS**

- Vdd = 1.8V
- Idd Core = 900nA
- Load Capacitance = 10pF
- Idd Output Driver: (65nA/V)(1.8V) = 117nA
- Load Current: (10pF)(1.8V)(32.768kHz) = 590nA
- Total Current = 900nA + 117nA + 590nA = 1.6μA

#### **Example 2: NanoDrive™ Reduced Swing**

- Vdd = 1.8V
- Idd Core = 900nA
- Load Capacitance = 10pF
- Vout<sub>pp</sub> (Programmable): V<sub>OH</sub> - V<sub>OL</sub> = 1.1V - 0.6V = 500mV
- Idd Output Driver: (65nA/V)(0.5V) = 33nA
- Load Current: (10pF)(0.5V)(32.768kHz) = 164nA
- Total Current = 900nA + 33nA + 164nA = 1.1μA

### Typical Operating Curves

( $T_A = 25^\circ\text{C}$ ,  $V_{dd} = 1.8\text{V}$ , unless otherwise stated)

**Initial Tolerance Histogram**

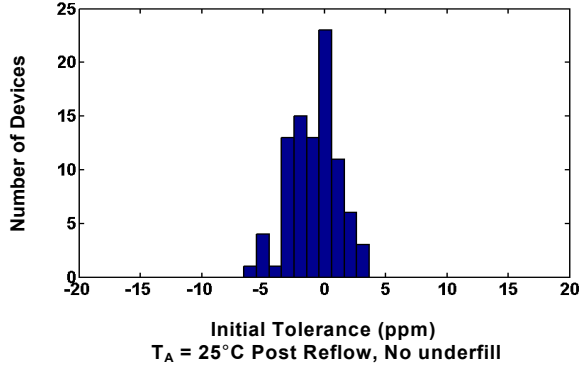

**Frequency Stability Over Temperature**

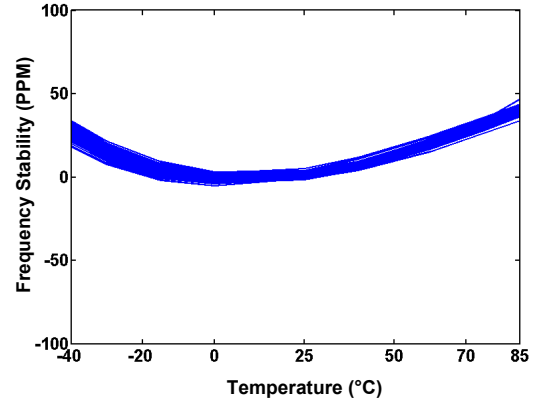

**Core Current Over Temperature**

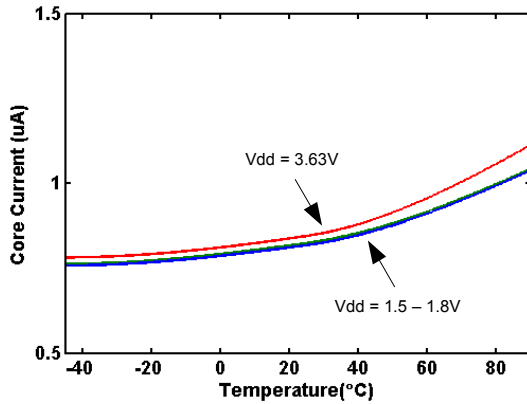

**Output Stage Current Over Temperature**

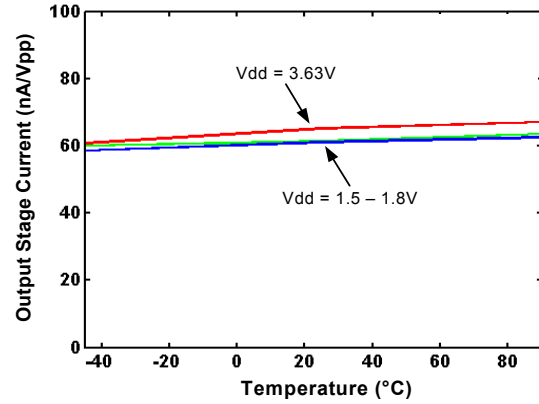

**Start-up Time**

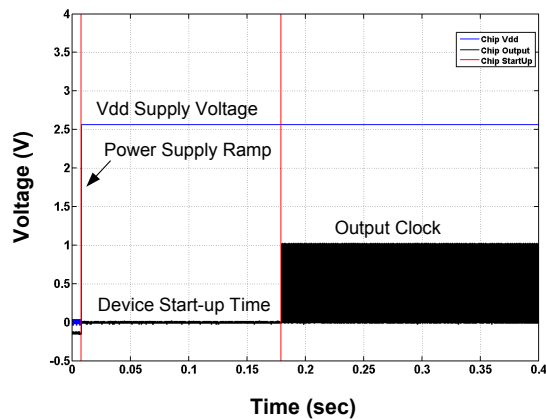



### Power Supply Noise Rejection (+/-150mV Noise)

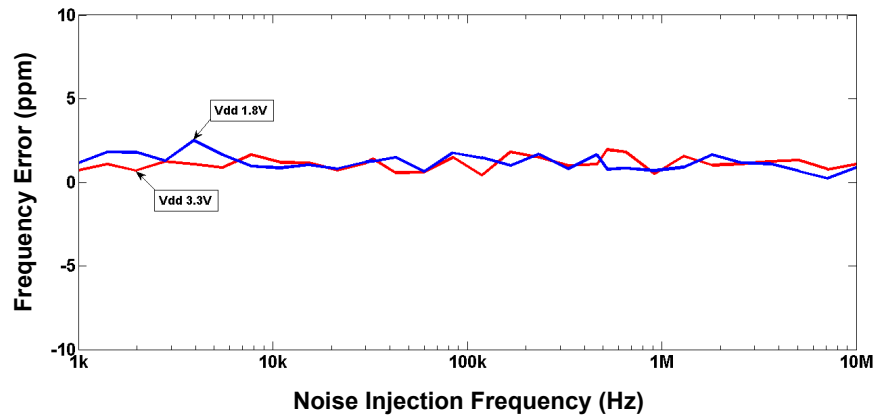

### NanoDrive™ Output Waveform

( $V_{OH} = 1.1V$ ,  $V_{OL} = 0.4V$ ; SiT1533AI-H4-D14-32.768)

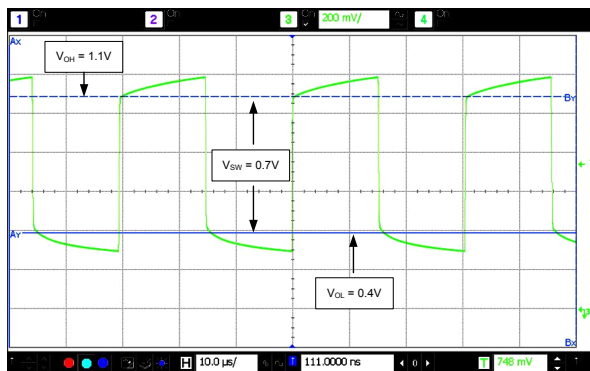

### LVC MOS Output Waveform

( $V_{swing} = 1.8V$ , SiT1533AI-H4-DCC-32.768)

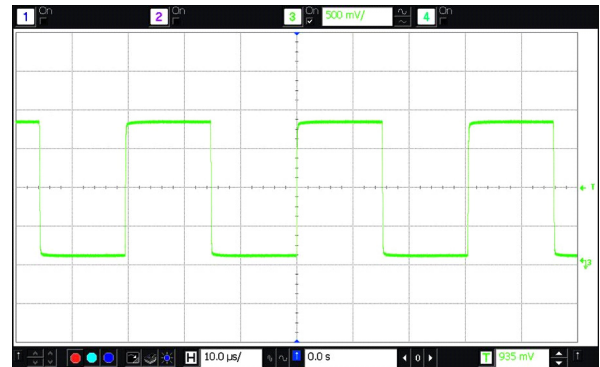



### Dimensions and Patterns

Package Size – Dimensions (Unit: mm) <sup>[7]</sup>	Recommended Land Pattern (Unit: mm)	
<p><b>2.0 x 1.2 mm SMD</b></p>	<p><b>SiTime Only SPL</b></p>	<p><b>XTAL Compatible SPL</b></p>

**Note:**

7. Top marking: Y denotes manufacturing origin and XXXX denotes manufacturing lot number. The value of "Y" will depend on the assembly location of the device.

### Manufacturing Guidelines

- 1) No Ultrasonic Cleaning: Do not subject the SiT1533 to an ultrasonic cleaning environment. Permanent damage or long term reliability issues to the MEMS structure may occur.
- 2) For Noisy, high EM environments, we recommend the following design guidelines:
  - Place oscillator as far away from EM noise sources as possible (e.g., high-voltage switching regulators, motor drive control).
  - Route noisy PCB traces, such as digital data lines or high di/dt power supply lines, away from the SiTime oscillator.
  - Add a low ESR/ESL, 0.1uF to 1.0uF ceramic capacitor (X7R) to help filter high frequency noise on the Vdd power-supply line. Place it as close to the SiTime oscillator Vdd pin as possible.
  - Place a solid GND plane underneath the SiTime oscillator to shield the oscillator from noisy traces on the other board layers.
- 3) For additional manufacturing guidelines and marking/tape-reel instructions, click on the following link: [http://www.sitime.com/component/docman/doc\\_download/243-manufacturing-notes-for-sitime-oscillators](http://www.sitime.com/component/docman/doc_download/243-manufacturing-notes-for-sitime-oscillators)

### Ordering Information

Part number characters in blue represent the customer specific options. The other characters in the part number are fixed. Here are guidelines to select the correct output voltage. These are only suggestions and specific chipsets may require different output voltage settings.

- 1) For XTAL replacement applications that will keep the chipset oscillator enabled, configure the NanoDrive™ output for a swing similar to the XTAL, approximately 250mV.  
→ SiT1533AI-H4-AA2-32.768
- 2) For XTAL replacement applications that will disable the chipset oscillator, configure the output with one of the following:
  - For VDD = 1.8V: SiT1533AI-H4-D14-32.768
  - For VDD > 1.8V: SiT1533AI-H4-DCC-32.768

The following examples illustrate how to select the appropriate temp range and output voltage requirements:

#### Example 1: SiT1533AI-H4-D14-32.768

- Industrial temp & corresponding 100 ppm frequency stability. Note, 100 ppm is only available for the industrial temp range, and 75 ppm is only available for the commercial temp range.
- Output swing requirements:
  - a) "D" = DC-coupled receiver
  - b) "1" =  $V_{OH} = 1.1V$
  - c) "4" =  $V_{OL} = 0.4V$

#### Example 2: SiT1533AC-H5-AA2-32.768

- Commercial temp & corresponding 75 ppm frequency stability. Note, 100 ppm is only available for the industrial temp range, and 75 ppm is only available for the commercial temp range.
- Output swing requirements:
  - a) "A" = AC-coupled receiver
  - b) "A" = AC-coupled receiver
  - c) "2" = 250mV swing

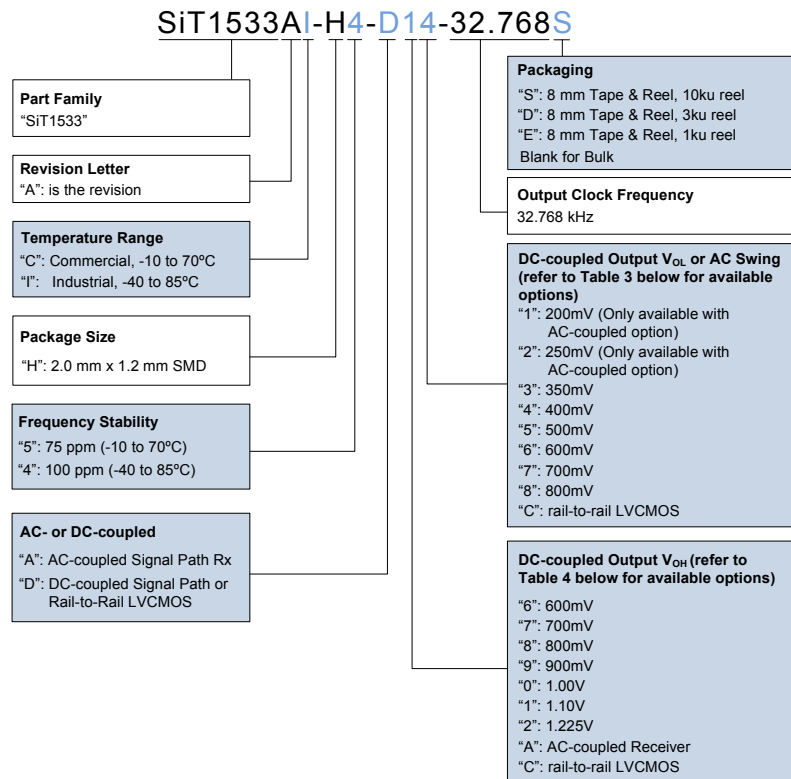

## Revision History

Version	Release Date	Change Summary
1.0	9/2/14	Rev 0.9 Preliminary to Rev 1.0 Production Release <ul style="list-style-type: none"> <li>• Updated start-up time specification</li> <li>• Added typical operating plots</li> <li>• Removed SOT23 package option</li> <li>• Relabeled 25°C frequency spec as <i>frequency tolerance</i></li> <li>• Added Manufacturing Guidelines section</li> </ul>
1.1	10/14/14	<ul style="list-style-type: none"> <li>• Improved Start-up Time at Power-up spec</li> <li>• Added 5pF LVCMOS rise/fall time spec</li> </ul>
1.2	11/25/14	<ul style="list-style-type: none"> <li>• Updated 5pF LVCMOS rise/fall time spec</li> <li>• Added additional design-in/mfg guidelines</li> </ul>

© SiTime Corporation 2014. The information contained herein is subject to change at any time without notice. SiTime assumes no responsibility or liability for any loss, damage or defect of a Product which is caused in whole or in part by (i) use of any circuitry other than circuitry embodied in a SiTime product, (ii) misuse or abuse including static discharge, neglect or accident, (iii) unauthorized modification or repairs which have been soldered or altered during assembly and are not capable of being tested by SiTime under its normal test conditions, or (iv) improper installation, storage, handling, warehousing or transportation, or (v) being subjected to unusual physical, thermal, or electrical stress.

**Disclaimer:** SiTime makes no warranty of any kind, express or implied, with regard to this material, and specifically disclaims any and all express or implied warranties, either in fact or by operation of law, statutory or otherwise, including the implied warranties of merchantability and fitness for use or a particular purpose, and any implied warranty arising from course of dealing or usage of trade, as well as any common-law duties relating to accuracy or lack of negligence, with respect to this material, any SiTime product and any product documentation. Products sold by SiTime are not suitable or intended to be used in a life support application or component, to operate nuclear facilities, or in other mission critical applications where human life may be involved or at stake. All sales are made conditioned upon compliance with the critical uses policy set forth below.

#### CRITICAL USE EXCLUSION POLICY

BUYER AGREES NOT TO USE SITIME'S PRODUCTS FOR ANY APPLICATION OR IN ANY COMPONENTS USED IN LIFE SUPPORT DEVICES OR TO OPERATE NUCLEAR FACILITIES OR FOR USE IN OTHER MISSION-CRITICAL APPLICATIONS OR COMPONENTS WHERE HUMAN LIFE OR PROPERTY MAY BE AT STAKE.

SiTime owns all rights, title and interest to the intellectual property related to SiTime's products, including any software, firmware, copyright, patent, or trademark. The sale of SiTime products does not convey or imply any license under patent or other rights. SiTime retains the copyright and trademark rights in all documents, catalogs and plans supplied pursuant to or ancillary to the sale of products or services by SiTime. Unless otherwise agreed to in writing by SiTime, any reproduction, modification, translation, compilation, or representation of this material shall be strictly prohibited.